



Lucid

DRONE TECHNOLOGIES

Operators Manual

C1 Cleaning Drone

VERSION DU1.1 3.31.22

Operations Manual Purpose

Lucid Drone Technologies is happy to welcome you to the C1 Cleaning drone and operations manual! The C1 Drone is a large hexacopter designed to make your cleaning operations more efficient and effective. The C1 drone is a tool and should be treated as such. The C1 drone can offer you the ability to evolve from cleaning on the ground... to cleaning from the sky.

The purpose of this operations manual is to educate you on drone operations, the C1 drone itself, operational procedures, maintenance and care procedures. By following this operations manual you can expect to get the most out of the drone, create seamless workflows and keep the drone working at maximum capacity.

This manual and our subsequent training will transform you into a Lucid Certified Operator. You will become a pilot, as a pilot you now hold the ultimate responsibility. To first become a pilot, you will have to acquire your Part 107 Remote Pilot Certificate. To become a Lucid Certified Pilot (LCP), you'll acquire your Federal UAS Certificate, demonstrate an understanding of aerial cleaning operations with the C1. Our all inclusive training program will help you understand drone operations, federal laws, the C1 drone, operational protocols and help you navigate various cleaning scenarios with the drone. All pilots must follow federal, state, and local regulations at all times. As drone law is quite new, Federal law will supersede most local regulations as the FAA is the only regulatory agency who controls the skies. Pilots must operate with caution and adhere to this operations manual to avoid failure, crashing and catastrophic loss.

It is imperative to understand that, similar to any tool, drone technology has limitations. There are instances when using the drone is the perfect solution, and instances when it is cautiously functional. There are also instances where drone cleaning is not a viable solution for that specific job. Understanding which of those instances fits each individual job is imperative to properly using the C1 cleaning drone. This Operator's Manual will work to explain these limitations so that you can determine whether or not the drone should be used.

This operations manual will help create systematic workflows to implement the use of the C1 cleaning drone. Pilots will learn the nuances of the aircraft, maintenance and care. There are many nuances throughout any drone operation. Our goal is to simplify these nuances to create habits that form into routines. With these routines your operations will become seamless and valuable to your business as a whole. By following this operations manual, pilots and companies will be maximizing your return-on-investment. This underscores a theme throughout the Operator's Manual: the C1 Cleaning Drone is a tool with important, but specific, capabilities.

It is the responsibility of the pilot to ALWAYS operate safely. The number one priority of the pilot is always safety. As pilot in command you must ensure a safe operation for every team member involved. It is the pilot's responsibility to ensure a safe flight, and much of this involves understanding the limitations of cleaning with drones.

Do not fly the C1 cleaning drone until you have completed the Lucid Training Program. To activate your warranty and customer service, you must complete the training program provided to you.

Table of Contents

Training & Operations Manual Navigation

- Training Program and Systems
- Proper Onboarding with C1

Safety

C1 Cleaning Drone Components

- Specifications
- Drone Frame
- Folding Arms
- Landing Gear
- Batteries
- Sprayer Nozzle
- Drone Sensors: GPS, Obstacle Avoidance
- Case and Packaging

Remote Controller

- Controller Diagram
- Control Surfaces
- Camera Controls for Photo/Video
- Telemetry Data

Batteries and Charging

- Battery Voltage & Percentage
- Battery Warnings
- Fail Safes
- Understanding Battery Safety
- Battery Charging

Transporting the Drone

- Transportation Guidelines and Recommendations

Repair Kit

- Tools and Accessories

Personnel & Equipment

- Pilot in Command
- Pilot Assistant
- Crew
- Safety Equipment and Mobile Kit

Mission Planning & Pre-Flight

- Weather considerations & Environmental Limitations
- Crew Preparation
- Drone Setup
- Hardware checklists
- Drone + Pump Combination
- Site Planning for Take-off/Landing
- Take off Areas and Precautions
- Flight Path Planning

Flying the C1

- General Flying Workflow *
- Fail Safes
- Finding MOCA (minimum obstacle clearance altitude)

- Flight Orientation
- Pre-Flight Quality Checks
- Take Off Procedures (Rules of Takeoff)
- In-Flight Cleaning Procedures
- Hazards of flying Tethered (Hose Attached)
- Landing Procedures

Mission Planning, Scouting Job Sites

- Macro Workflow Overview to include FAA Protocols and C1 Protocols
- Visualizing the Flight Path
- Operational Limitations
- Emergency Planning

Maintenance Schedule:

- Timeline for Maintenance

Conclusion:

- Importance of creating systems of operation
- Resources for team use
- Troubleshooting
- Customer Support

Training & Operations Manual Navigation

This operations manual was developed in conjunction with our training program. As a C1 drone owner you will gain exclusive access to the training portal. The training portal was developed with the help of Drone U. Whether you're just taking flight, or getting your systems right... the training program will transform your team into competent and knowledgeable pilots. Your pilots should know the drone inside and out. They should understand the regulatory environment and how to operate within it. The training portal includes all of the necessary training to acquire Part 107, learn the basics of drones, operations and specifically how to operate and maintain your C1 cleaning drone.



If you are reading this manual prior to accessing the training portal, stop right here.

Lucid flight crew would recommend you start with the training portal and use the manual as a resource to augment the training. The operations manual should be your guide along the adventure of evolving your cleaning business.

Training Program & System

The Lucid drone training program was built assist pilots from zero to hero. The training program will be vital to help your pilots gain Part 107 certification, learn drone systems and learn how to properly operate and maintain the C1 drone.

The Lucid Drone training program, powered by Drone U's Props, is built to not only train your pilots but also ensure completion and success. With so many nuanced systems to remember and follow, we have to simplify these systems by creating habits and routines with your pilots.

The training portal will also help you manage pilots training progression. It will empower program managers by organizing all pilot data, training information and equipment information. The program is vital to success as your pilots will all be operating on the same systems, following the same routines. This will allow for consistent success, decrease down times and provide continuity with all your members.

Training Program Navigation & Onboarding

Let's get started with the C1 by starting with the training portal. Managers will have initial access and can invite pilots/crew to the portal to get started.

Log Into your Portal Here: _____

Invite your pilots and have them enter their information and start the program.

Pilot Navigation:

1. Welcome and Explanation Video
2. Legalities and Regulations
3. Part 107 Preparation
 - a. Pilots have the option to skip by providing their P107 certificate number
4. Operations Course

- a. Pilots have the option to skip the course by completing a quiz with a higher than 80% score.
5. Comprehensive drone Course
6. Lucid C1 Aircraft
7. Aircraft Care and Transportation
8. Operational Protocols
9. Training Procedures and Protocols
10. Operations Planning
11. Operational Scenarios
12. Certification Quiz
13. Extra Option Courses and Flight Practice Guidelines

The operations manual navigation parallels the training program to create a more seamless experience. It will also aid in recall while conducting drone operations in the field. Print out this operations manual and use it as a reference when taking the training programs.

The training program is built to help pilots fully understand drone operations as a whole. Pilots will be educated on operational procedures for flight operations. Pilots will then move onto the C1 cleaning drone and the specific operational protocols for the aircraft. With this navigation, pilots can warm up and become comfortable with drone operations before moving into the C1 drone. With this navigation path, pilots will gain confidence and learn the habits to conduct cleaning operations.

As a part of the training program, you will be given resources to aid your pilots in the field. These resources include documentation like a pre-flight checklist, workflow guide and more. Your pilots will only gain access to those resources once they reach a training threshold. Once pilots progress to this threshold, they will unlock these resources to use in the field.

We hope you enjoy the training platform and know it will transform your cleaning crews from zero to hero!

Safety

Safety & Responsibility

The pilot operating the C1 drone holds the ultimate responsibility during operations. According to FAA regulations the Pilot in command is ultimately responsible for the safety of the operation as well as the crew.

When taking flight with the C1 drone, pilots should conform to all applicable Federal Regulations as advised under Part 107 of the regulations. Pilots should also adhere to any state or local regulations regarding the limitations of takeoff and landing or privacy. It is the responsibility of the pilot and program manager to know these regulations.

The Pilot in command will be held responsible for actions of the crew, manager and his/her own actions. The pilot in command should ensure that every operation starts with a safety briefing.

Safety Briefings

Pilot in command is regulated to conduct a safety briefing prior to every flight. The FAA states that the safety briefing should address the following:

1. Notate the area for takeoff and landing
2. Describe the area of flight operations
3. Showcase how pilot and VO will ensure bi-standers do not enter the area of take off and landing
4. Pilot should notate emergency landing areas,
 - a. If something should go wrong where will the drone be dumped?
 - b. Where is a secondary landing location
 - c. Communication protocols to notate an in-flight emergency
 - i. IE. Communicating “Red, Red, Red.”
5. Pilot should notate operational conditions
 - a. Weather
 - b. Airspace
 - c. KP Index
 - d. RFI or EMI (interference to the radio, ie. wifi dense environments)
 - i. Operational protocol if communications cease with drone.
6. Pilot should notate local point of contact
7. Pilot should showcase the goal and deliverables of flight mission
8. Pilot should notate operating environment and obstacles
 - a. Pilot should communicate “MOCA,” or minimum obstacle clearance altitude
9. Pilot should notate nearest bathroom, hospital and emergency communication procedures in the case of an emergency.
10. Pilot should notate any precautionary measures due to the chemical being sprayed
11. Pilot should notate minimum safe distances from the aircraft and identify who is responsible for keeping bystanders and crew members safe of the area of operation.

Operating Limitations



Operating the C1 cleaning drone outside of FAA regulations and in a manner other than described in this manual is unsafe and could lead to catastrophic failure. While drones limit liability for cleaning, they can also increase liability if not used in accordance with this operating manual or federal regulations.

C1 Operational Limitations:

1. Drone should not be operated within 30 feet of any person, or crew member.
2. Takeoff and Landing area should be cordoned off with cones, high visibility tape or other means.
3. Drone should never be operated above people.
4. Lucid recommends the flight area, in addition to the takeoff area, should be cordoned off to eliminate foot traffic when possible.
5. Pilot should notify and communicate that drone operations are in progress
 - a. Lucid recommends posting a sign of “Aerial Cleaning Operations in Progress,” please stay clear of the drone and pilot.

Safety Equipment & Recommendations

Lucid recommends that all pilots and crew be easily identifiable during aerial operations. Pilots should be wearing the following personal protective equipment during operations.

1. High Visibility Vest
2. Hardhat
3. Eye Protection

Additional Safety Equipment

1. Microfiber towel and approved cleaner to spray the drone down
2. [Purple K Fire Extinguisher](#) in case of battery fire
3. [Medical Kit for Emergencies](#) that includes trauma kit for lacerations.

Additional Recommendations:

1. Pilot and VO or pilot assistant should have a hands-free means of communication via radios. Various options are available on amazon. Pilots may find the BB-talk radios a viable solution as the radios are waterproof and offer a hands free method of communication. Find those radios here: <https://www.bbtalkin.com/product-page/kite-wind-surf-1>
2. Pilot and VO should identify any potential areas for a hose snag. A hose snag can cause the aircraft to enter a death roll. Pilot Assistant should know potential hose snag points and avoid areas as best as possible. Pilot assistant should have a plan to ensure hose slack and direct hose **WITHOUT STANDING BELOW THE DRONE.**

C1 Cleaning Drone Components and Specifications

C1 Drone Specifications

The C1 cleaning drone is a large hexacopter with multiple sensor failsafes. It was built to carry hose lines to perform cleaning operations. Due to the specific nature of this drone, the operational protocols may differ from other drones and subsequent operations.

Please note that while these specifications are accurate, the data was aggregated from the drone flying in pristine flight conditions.

The specifications of this drone are malleable due to the operating conditions. Specific operating conditions will change the operating specifications of the aircraft.

Environmental Conditions that could change operating expectations from the C1:

1. Wind
 - a. (higher winds will decrease flight times)
2. Elevation:
 - a. (higher elevation will decrease flight times)
3. Temperature
 - a. (Temperature extremes will affect flight times)
4. Humidity and Dew Point
 - a. (Humidity could change density altitude and affect aircraft performance.)
5. Payload
 - a. Heavier payloads will decrease aircraft performance
 - b. Lighter payloads will increase aircraft performance
6. Batteries
 - a. Improper battery care can decrease aircraft performance

Drone Specifications

(Data aggregated from low winds, moderate temperature and low altitude)

C1 Weight (At Takeoff without hose attached):	27lbs
Flight Time	12-20minutes
Aircraft Diameter	53"
Aircraft Height	24"
Operating Altitude:	Limited to 115'
Operating Radius:	Limited to 200'
Batteries	Dual (2x) 6s 16000mah LiPo

Aircraft Frame

The C1 cleaning aircraft is built on a carbon-fiber hexacopter frame. The frame is analogous to a planes "fuselage," and should be treated with care. The carbon fiber frame provides a rigid platform to attach the flight controller, motors, esc's, propellers and sensors.

The aircraft frame is specifically designed to support the aircraft and all ancillary components.



Pilots should not move, adjust, attach or remove any part or piece of the aircraft. The aircraft is balanced to ensure the center of gravity is directly below the flight controller and IMU. If the aircraft becomes unbalanced, it will lead to a catastrophic failure or crash.

The frame is built with 3 quintessential parts:

1. Body
2. Arms
3. Landing gear.

Arms:

The arms of the C1 cleaning drone house the aircrafts ESC's and provide the mount points for the motors. The ESC's control the speed of the props down to the micro-second. The arms should always be fully elevated and locked into place when preparing for flight. If the arms become unstable, twist or do not lock into place, **DO NOT FLY**. Over time, and dependent on usage, arm mount screws may need to be tightened to ensure tight fit and proper flight. Vibrations can cause screws to loosen over time, and pilots should always ensure the arms are fully locked into place without any play.

Landing Gear:

Landing gear allows the drone to safely take off and land with proper clearance from the ground. Landing gear is made up of 4 carbon fiber poles which support the aircraft frame. The landing gear is specifically designed to allow for maximum hose flexibility in flight. With this landing gear design, the hose should never get snagged on the landing gear or inhibit a safe landing.

The landing gear is permanently attached to the aircraft and can not be removed. Pilots should ensure screws remain tight over time, as vibrations can cause screws to loosen.

Batteries

The C1 cleaning drone requires dual batteries for each and every flight. This battery setup provides a necessary redundancy to pilots. In the event of a battery cell error, the aircraft should remain airborne. Battery care is **VITAL** to continued success with the C1 drone. This operations manual will cover proper battery care, storage and charging to ensure your batteries maintain the maximum endurance or life span.

Each battery is a 6s 16000mah with operating voltages between 3.3v - 4.2volts per cell. Each battery has 6 cells wired in serial. Battery cell voltages are displayed as an aggregate voltage, rather than a per cell voltage. Each battery operates at a maximum aggregate cell voltage of 25.2 volts. When both batteries are installed,

the remote will showcase an aggregate voltage of both batteries combined. I.e. Battery voltage will display as 50.4 voltages to 42 volts. When aggregate battery voltage depletes to 42 volts, pilots should **land immediately**. Each battery has two sets of wires protruding from the cell pack. The larger thicker gauge wires are connected to an EC5 port and provide power to the drone. The blue EC5 port connectors are plugged into the corresponding receiver on the drone. The second set of smaller, thinner wires provide battery information to the flight controller, and power the battery indicator/warning lights. These smaller and thinner set of wires are defined as our balance wires. The 7 smaller balance wires have a smaller white connection port.



When plugging the batteries into the drone, ensure the battery port connector is properly aligned to the corresponding port. Ensure that the red wires are plugged into the corresponding port correctly, so the red wires from the battery are matching the red wires on the aircraft! Ensure the black wires on the battery are plugged into the corresponding port matching the black wires from the aircraft. Crossing these power lines can cause catastrophic failure to the battery and drone.



C1 drones should never be flown without FULLY CHARGED BATTERIES. Do not fly the C1 drone on batteries that have been flown previously, without being recharged. Do not fly the C1 on partially charged batteries, as cell depletion is accelerated and can lead to catastrophic failure.



Batteries should always be stored in fire-proof bags. Batteries should always be charged on a fire-proof surface. Batteries should never be left unattended while charging. Do not charge these batteries while sleeping or if a person is not present.



Do not ship batteries via air, ever, per FAA regulations. When traveling via air carrier or via plane, do not check your batteries. Batteries must be carried on board the aircraft. FAA does have limitations on batteries that can be brought onboard an aircraft. It is the pilots responsibility to know these FAA regulations.



Handle batteries with extreme care. Do not puncture batteries and do not drop the batteries. If batteries are dropped ensure the protective shield has not been damaged or cut. If the battery is indented, do not fly with the battery. Replace it immediately.



Batteries should maintain their shape. If a battery becomes PUFFed, immediately replace the battery and do not fly with it. Puffed batteries showcase a battery failure.

Motors

The motors on the C1 drone spin the propellers to create thrust and lift. The motors are brushless electric motors. The C1 drone's hexacopter design requires 6 motors on the aircraft. Motors on the drone are quintessential to sustain flight. These motors are waterproof and will operate in wet weather conditions.

The C1's hexacopter design does offer protection and redundancy in flight by offering 6 motors. The drone can still sustain flight if one motor fails mid flight. When one motor fails, the drone will start to spin aggressively. Pilots can inhibit spin by actuating the yaw command in the opposite direction of the spin. The drone will not stop spinning but can still land.

Aircraft motors should remain clean and free of debris. Prior to any flight, Pilot in command should rotate motors and props. The motors should spin freely and silently. If motors make noise or do not spin freely, you must clear the debris in the motors prior to flight. Any material can inhibit the motor from spinning, which is why it is VITAL to clean the drone and motors after every cleaning flight.

Propellers

The C1 drone is outfitted with 6 propellers that spin up to 10,000 rpm while in flight. The folding propellers offer significant advantages over fixed propellers. The folding propellers offer additional stability and reduced noise via micro vibrations sustained in flight.

Propellers should always be stored in a folding position. Prior to any flight, the Propellers should be unfolded to create a straight line. Do not let the propellers be unfolded by starting the drone motors. Over time this will cause significant vibrations and cause the aircraft to age faster than it should.

Once the Aircraft is turned on, the propellers should not be touched by any individual. Do not touch the propellers upon landing until the aircraft has been powered down. Never attempt to touch the motors while spinning or in flight.

Lucid Drone Technologies recommends having a spare set of propellers. Propellers should be replaced after 50 hours of flight. Approximately that is 150 - 300 flights dependent upon operating conditions. Propellers are the most sensitive part of the aircraft. If propellers become unbalanced at any point, the props will fail and cause a catastrophic failure.



If propellers strike any object, they should be replaced immediately. If the C1 drone hits a bush, tree branches or even small vegetation, replace the propellers.. Propellers are cheap to replace, the C1 drone is not.



Never touch the propellers when the drone is powered on. Never approach the propellers or the drone, under any circumstance, when the propellers are in motion.

Spray Nozzle

C1 cleaning drone offers a detachable spray nozzle that connects to the drone. The spray nozzle should only be affixed to the drone prior to a flight. The spray nozzle should not stay affixed to the drone while in storage or transport.

The spray nozzle attaches to the aircraft via a quick connect propeller, located beneath the main frame of the aircraft. The spray nozzle offers multiple tips to empower users for various spraying applications. The primary nozzle tip will provide a flow rate of 6.5 - 7.5 gallons per minute.

Hose Attachment

Lucid drone technologies has selected the Banjo Polypropylene Cam & Groove fitting to attach a pump hose to the drone. The fitting is mounted below the drone and plumb to the ground. The fitting offers a 3/4 " coupling size, made to support a 1/2" hose.

C1 users may need to purchase a [male counterpart](#) to utilize this fitting/connector in order to attach it to a 1/2" hose.



Prior to takeoff, ensure your hose is properly attached to the aircraft. Failure to do so may cause an in-flight emergency.



Prior to takeoff, ensure the sprayer nozzle is properly attached to the aircraft. Failure to do so may cause the nozzle to act as a projectile and cause damage to nearby subjects.

GPS Antennas

The C1 drone comes with two (2) detachable GPS antennas used to provide heading and direction to the aircraft. The two (2) antennas look like small black cylinders that can be found in your remote case. Prior to each flight, install the two antennas on the top of the aircraft. Antennas are affixed to the drone via small 1/4" screws. Screw the antennas onto the drone, **hand tighten only, DO NOT OVER TIGHTEN THE ANTENNAS.**

The antennas must be affixed to the aircraft prior to each flight. Take the antennas off of the aircraft after each flight for transportation of the aircraft.





Prior to takeoff, GPS antennas must be attached to the drone in order to takeoff.



Remote Controller

The C1 cleaning drone comes with an H16 Remote Controller which the drone pilot will use to control the drone. The remote controller allows the pilot to actuate the aircraft, control obstacle avoidance, view the camera feed and provide live telemetry from the aircraft.

The remote control comes with a built in tablet displaying flight-necessary information in real time. During flight, pilots are informed of their altitude, heading, distance, GPS data, camera view and current battery status.

The Remote Control will come in a grey case to protect the buttons and sticks. Never store or transport the remote control, unless it is in the case. If the control sticks rest against anything, it can throw them out of balance. The sticks will no longer be at zero and cause permanent damage to the remote.

Controller Case Includes:

1. Remote Controller
2. USB-C Wall Charger
3. USB-C Charging Cords
4. Neck Strap
5. Antenna Covers
6. GPS Antennas (as discussed above)

Remote Control Diagram

1. Di Pole Antennas
2. Sprayer Relay
3. Not in Use.
4. Left Joystick (Controls elevation and yaw or rotation)
5. D Pad for menu navigation
6. Power Button
7. Flight Control Modes
 - a. ABC Buttons = Loiter or GPS Mode
 - b. DEF= Landing mode
8. Aircraft Flashlight
9. Right Joystick (Controls Pitch & Roll)
10. Obstacle Avoidance Switch
11. Arm / Disarm the Aircraft (Starts and stops motors)
12. Aux (not in use)
13. Aux (not in use)

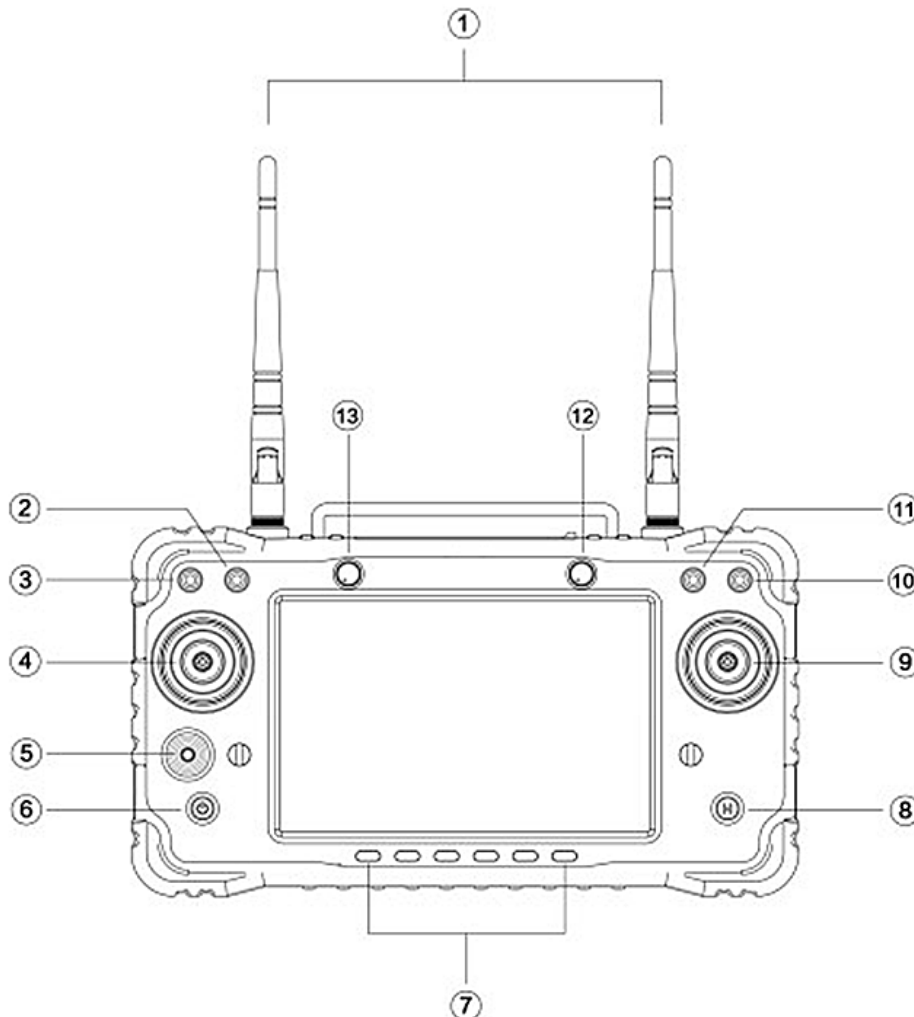

Remote Controls Explained

1. Di Pole Antennas
 - a. Antennas allow for radio communication between the remote and the aircraft.
 - b. In typical operations, the antennas should be unfolded to approximately a 45 Degree angle. Each antennas should be twisted towards the outside edge of the remote.
 - c. The radio signals do not come from the tip of the antennas, rather the signals radiate from the facade of the antenna.



2. Sprayer Relay
 - a. Upward Toggle Position = Sprayer On
 - b. Downward Toggle Position = Sprayer Off

3. Not in Use.

4. Left Joystick (Controls elevation and yaw or rotation)
 - a. Pressing the left stick forward will cause the aircraft to elevate or ascend
 - b. Pressing the left stick down will cause the aircraft to descend.
 - i. Note: Never fly the aircraft straight down.
 - c. Pressing the left stick to the left, will cause counter clockwise rotation on the aircraft.
 - d. Pressing the left stick to the right, will cause a clockwise rotation on the aircraft.

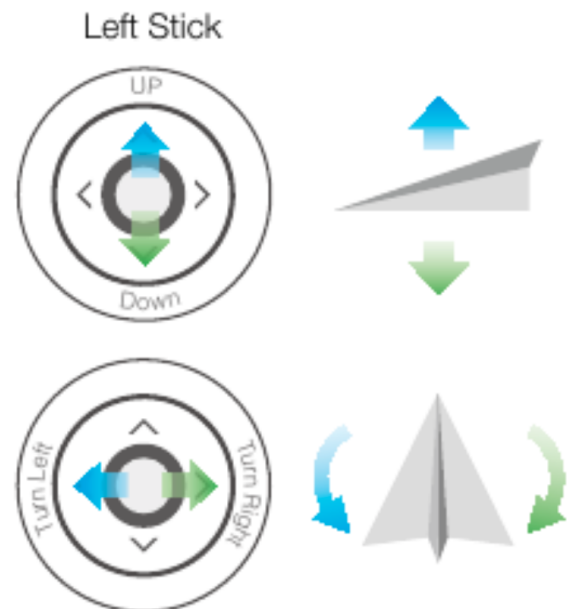

5. Not in Use.

6. Power Button

- a. Depressing this button, and holding it for 3 seconds it will turn the remote on.
- b. Depressing and holding the button while the remote is on, will turn the remote off.

7. Flight Control Modes

- a. ABC Buttons = Loiter or GPS Mode
 - i. Loiter mode or GPS mode is the default flight control mode. This control mode assists the pilot to maintain altitude and straight line flight by utilizing GPS positioning. When the pilot releases the sticks, the aircraft will hover in place.
- b. DEF= Landing mode
 - i. Landing Mode will cause the aircraft to descend straight down and land. This particular flight mode should **not be used for regular landing**.
 - ii. This flight mode will cause the aircraft to descend rapidly **in the case of an emergency**.
 - iii. The pilot can still “nudge” the drone by using pitch and roll, while the aircraft is landing.

8. Aircraft Flashlight

- a. Pressing this button will turn the Aircraft's flashlight On and Off.

9. Right Joystick (Controls Pitch & Roll)

- a. Right joystick will control all lateral motions with the aircraft.
- b. Pitching forward will cause forward motion with the drone.
- c. Pitching Backward will cause a reverse motion with the drone.
- d. Rolling the aircraft to the left will cause a lateral motion to the left.
- e. Rolling the aircraft to the right will cause a lateral motion to the right.

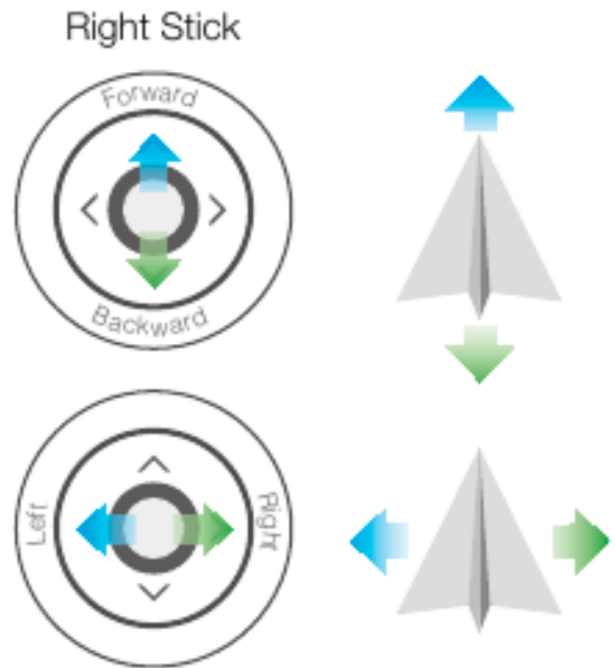

10. Obstacle Avoidance Switch

- a. This toggle is used to control the obstacle avoidance system which limits the drones motion if an object is detected. When the obstacle avoidance is turned on, the drone will prevent the pilot from flying the aircraft into an object **that is in front of the drone**.



Obstacle avoidance only works in front of the aircraft. Objects to the side or behind cannot be detected. Obstacle avoidance should also be a last resource for the pilot. While it is a great aid, it should not be relied upon. Objects that reflect light may cause the obstacle avoidance to fail.

11. Arm / Disarm the Aircraft (Starts and stops motors)

- a. This toggle is used to start the motors upon takeoff, and turn off the motors upon landing. The arming switch has an attached covered to prevent accident toggle switching. Toggling the switch off during flight will cause all motors to seize and immediately inhibit flight.



Never toggle the arming switch in flight, this will cause an instant crash.

12. Aux (not in use)

13. Aux (not in use)

Batteries & Charging

Battery Management

The most common drone crashes occur due to a **lack of battery management**. Lack of battery management can look like:

1. Flying the C1 Drone without Fully Charged Batteries
2. Failure to check battery voltage level in flight
3. Failure to calculate environmental conditions for flight
4. Pushing the battery beyond operating voltage.
5. Failure to deep cycle batteries every 10 flights
6. Failure to store batteries properly
7. Failure to protect batteries from drops/damage

Pilots can avoid most drone related problems by caring for batteries and creating operating systems to ensure safe flights. With simple habits, pilots can avoid most common pitfalls and problems.



Lucid C1 Drone should only be flown with FULLY CHARGED BATTERIES.



Lucid C1 Drone requires Dual (2) 6S batteries to take flight.



Flight times are not guaranteed. Flight times are affected by environmental conditions including weather, temperature, wind and humidity.



Pilots must monitor battery status during the duration of the flight. Pilots should land when the aircraft reaches 42 volts.

As per FAA guidelines, the Pilot is ultimately responsible for the safety of the flight, operation and crew. As such, the Pilot should always ensure that **both batteries are fully charged prior to flight**. Pilots should not fly the C1 drone on **partially charged batteries**.

Typical flight times:

Flight time on the C1 drone can vary due to payload, hose size and environmental factors.

Flight times for C1 Drone are as follows:

8-16 Minutes In a hover.

How to confirm batteries are fully charged:

1. Battery Voltage Gauge

- a. To display battery voltage, please plugin the Battery Balance cable into Battery Voltage indicator
 - i. To plug battery balance cable into indicator, ensure that the red wire is closest to the bottom of the battery indicator. Balance plug plastic guides will be on the top of the balance plug facing the pilot when plugging it.
- b. Fully Charged Battery will Display over 25 to 25.29 Volts



2. Drone Voltage Display

- a. Plug Batteries into drone, turn on the remote. Enter QGround Control application on the remote and press the battery icon located on the top of the app interface to display aggregate battery voltage.
- b. Fully Charged battery will display over 50 volts (Aggregate of both batteries combined)

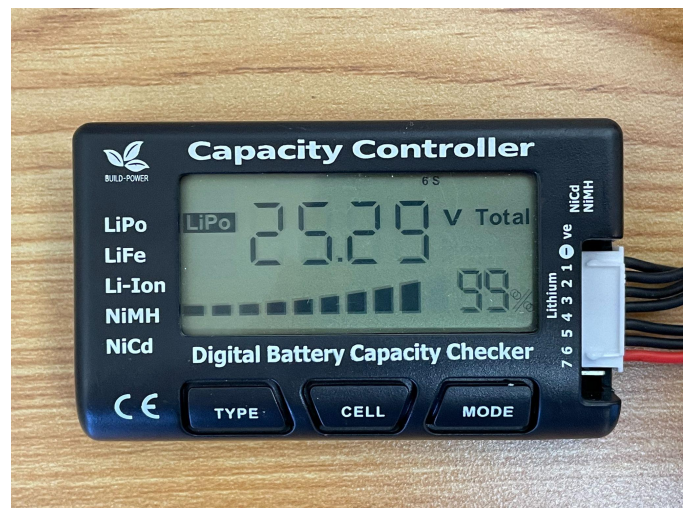

Please note the C1 drone will not take off in the event that battery voltage is below 42 volts.

Checking Battery Status & Remaining Flight Time

In order to check battery status or remaining flight time, the pilot must understand how to gauge remaining flight time.

1. Battery Voltage will fluctuate between 50 and 42 Volts
 - a. Full Battery = 50 Volts
 - b. Empty Battery = 42 Volts

Batteries used for drones are typically built as Lithium Polymer batteries and have an exponential depletion. Drone batteries typically operate between 100 to 30%, below a particular percentage or voltage, batteries will lose power exponentially and cause a crash.

In order to determine available flight time, pilots will have to keep an eye on battery voltage during the flight.

Battery Warning Light

The Lucid C1 drone offers a battery status light. This battery warning light will begin to flash when battery voltage has been depleted to 42 volts.

The battery warning light is powered by the balance wires from your drone batteries. The small voltage will power the battery lights and begin to flash as the batteries deplete.

When the battery warning lights flash, *it is time to land the aircraft to avoid a crash.*



Continuing to fly when the battery warning light strobes can lead to permanent damage to the aircraft and the batteries.



When installing the batteries prior to a flight, ensure that main power cables are plugged into the corresponding connector with the correct orientation. I.e. Red Wires connect to corresponding red wires. Do not cross the wires, as doing so will create a short circuit and damage the batteries and aircraft.

Battery Fail Safe:

After the battery warning light has begun to strobe, the Pilot will have approximately 2 minutes to land. Following the 2 minutes, the battery fail safe will trigger and begin the auto-landing procedure.

When the fail safe is activated, the drone will begin to descend...commencing the auto landing feature.

Pilots will not have control of altitude. Pilots can nudge the aircraft with the roll inputs and pitch inputs. This way the pilot can still control where the aircraft lands.

Battery Safety Protocols:

Experienced drone pilots understand the most dangerous aspect of the aircraft is the battery. The batteries are the most sensitive part of the aircraft itself.

If you have experience using power tools, the batteries built for those tools are much more robust and safer as a whole.

LIPO Batteries must be treated with care.

Battery Storage Procedures:

When batteries are not in use, they should be stored as follows:

1. Stored in LIPO Safe Bags to Prevent Fires
2. Stored between 40-80 degrees
3. Never left in direct sunlight

Battery Storage During Operations:

1. Keep batteries out of direct sunlight.
2. Keep the batteries in a cool place, do not store them in a hot vehicle.
3. Always keep the batteries in the shade

Storing Batteries while charged can damage the battery.



Never store drone batteries fully charged, never leave batteries fully charged and in storage longer than 10 days.

Battery Damage:

Damage to battery cells must be taken extremely seriously. Dropping the battery from even a few feet can cause an indentation in the battery. If the casing of the battery becomes dented, the battery should be recycled and discarded.

Example of Swollen Batteries:

Battery on top: swollen or puffy from improper storage.

Batteries on the bottom illustrate a battery cell damage

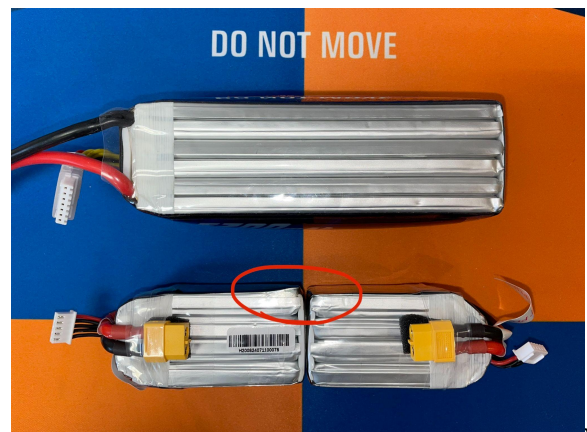

Smoke:

If the battery is emitting even a small amount of white smoke immediately evacuate the area and follow local fire protocols. The smoke and gas is extremely toxic and can cause choking and death.



Do attempt to handle the battery if it is smoking. While all patrons should evacuate the area, you can spray the battery with a fire extinguisher. It must be a “purple K” rated extinguisher.

Fire:

If a battery catches fire, follow internal emergency procedures. It is not advised to fight the fire with water or traditional methods of fire retardation. **Only a purple k fire extinguisher will put out a LiPo fire.** The fire will emit toxic gas as it is emitting smoke, the area should be cleared of personnel immediately.

Battery Disposal:

When batteries end their life cycle, it is the pilots responsibility to properly dispose of the batteries. Failure to do so can result in additional liability. If a battery shows signs of damage or distress, you will need to discharge the battery and recycle the batteries at your nearest battery retailer. (Batteries Plus)

In order to recycle any battery it must be discharged. You will need to fill a non-metallic bowl or bucket with water and salt. Ensure there is enough water to fully submerge the batteries. While the amount of salt is not absolutely formulaic, for every liter of water, you should add a ¼ cup of salt. The battery should be left submerged for a minimum of 24 hours. Do not use a metallic bucket, some plastics can break down as well. We recommend a glass or porcelain bowl to discharge batteries.

How to discharge batteries for recycling (Recap)

1. Fill Glass or Porcelain Bowl/Bucket with Water
2. Add ¼ cup salt for every liter of water.
3. Fully Submerge batteries in water
4. Leave batteries submerged in water for 24 hours.
5. Remove batteries from water and transport them to nearest battery recycler.









Battery Charger

Each Lucid C1 drone comes with a dual battery charger, housed in a case. The charging case will contain a dual battery charger, two battery charging cables, and two balance cables. The battery charger will allow users to charge two batteries at once when plugged into a standard 110 outlet. Typically users will have to plug the provided cables into the charger prior to use.

How to Charge Batteries.

Your Lucid charging cases will come pre-programmed and the user will not need to alter settings for initial charging. To charge the batteries, follow these steps:

1. Plug in power connectors from charger to batteries
2. Plug in the balance cable from the charger to the batteries (use notches to align the plug)
3. Once you plug in the batteries to the charger, the charger should display a 6 cell battery with operating voltages from 2.5v to 4.2v (per cell)
4. Press the circle button once to bring up the charging menu
5. Ensure the charging screen matches the image to the right.
6. Press the circle button again to “Start” charging
7. The screen will turn **red** and the batteries will begin charging
 - a. Typical full charge time will vary, but expect 40-60minutes
8. Once the battery is almost finished charging, the screen will illuminate **green**. This means the charger has entered the balancing phase to ensure the battery is fully charged.
9. Once the balance phase has completed, the charger will beep twice and the screen will turn **blue**.
10. To finish charging, press the circle button to end the balance cycle and unplug the batteries.

Task Setting 	
 Task	Charge
 Chemistry	LiPo
 Condition	4.20V
 Cells	6S
 Current	16.0A
 Start	
 Back	

How to Discharge Batteries.

Batteries will need to be discharged in order to be stored properly. Typically battery discharging would be used when batteries need to be stored longer than 10 days, batteries need to be deep cycled, or the battery cells have become unbalanced. (ie. cell deviation of .5v or greater)

To discharge the batteries, follow the following steps:

1. Follow steps 1-3 as stated above
2. Press the circle button to navigate to the option screen.
3. Press the upper triangle button to navigate to the task menu (at the top)
4. Select discharge to deep-cycle the batteries or balance them.
5. Select “Storage option” for storing the batteries longer than 10 days
6. Once you have selected the correction option, use the lower triangle button to navigate back to the start icon.
7. Select start with the circle button to begin the discharge or storage cycle.
8. Discharging the battery will take several hours to complete.

Charging Safety:

Ensure to never cross the wires for charging. By crossing the wires, the battery will short circuit and cause serious harm to the user and destroy the battery. When charging batteries please adhere to the following guidelines:

1. Charge your batteries in a climate controlled environment, near room temperature (70 degrees)
2. Never charge batteries that are hot. After a flight, batteries will typically be warm to the touch. Users should allow the batteries to cool down before charging. Failure to do so will result in a decreased lifespan.
3. Do not unplug the battery charger while the batteries are plugged into the charger. Always disconnect the batteries from the charger prior to unplugging the charger from the wall.
4. Charge the batteries on a fire proof surface
5. Keep the batteries in fire resistant cases while transporting, storing or even charging the batteries
6. Keep a fire extinguisher (purple k) within close proximity of the charger in case of a fire.

Transporting the Drone

Drone Transportation Case

The Lucid C1 drone case is approximately 24” cubed. The case is waterproof and Lucid recommends you have the drone in the case while traveling to and from a job site. When storing the drone in your office or indoors, we recommend a secure location.

Note: When transporting the Lucid C1 drone in the case, secure the case so it cannot move around. For example, do not put the case in the back of a trailer and allow it to bounce around.

Excessive vibrations will cause problems with the drone.

Drone Transportation Wagon (If Purchased)

The transportation wagon should be loaded with all of the accessories needed on a job site. This includes:

1. Batteries
2. Battery Charger
3. Remote Controller
4. Cones, Tape, High Vis Vest, Protective Equipment

Customer Repair Kit

Customer repair kit is offered to clients to provide tools to make on the job adjustments easier. In addition, Lucid has provided additional propellers and accessories to aid in the maintenance of the aircraft.

Customer Repair Kit Includes (If Purchased)

1. 1.5mm Hex Key
2. 2mm Hex Key
3. 2.5mm Hex Key (Most uses)
4. Loctite Screw Adhesive
5. 3m Adhesive Mountain Pads (10)
6. Level
7. M3 x 8mm screws (10)
8. Spare CW Propeller
9. Spare CCW Propeller

Personnel

Lucid Certified Pilot (LCP or RPIC)

LCP or RPIC is responsible for the safety of any given operation. They are also ultimately responsible for all aspects of the operation as a whole. Lucid recommends the LCP should:

1. Familiarize themselves with this Operators Manual
2. Do not deviate from the manual, unless necessary to ensure safety of the operation and personnel.
3. If LCP encounters a problem not addressed in the manual, suspend operations and contact Lucid's support team.
4. LCP should always use their judgment to determine if a safe operation is plausible.

Pre-Flight

It is the responsibility of the LCP to complete the required pre-flight procedures and checklist PRIOR to every flight. If the LCP is unable to successfully complete the pre-flight procedures, it is the responsibility of the LCP to ensure that the drone is used in a safe manner. This drone is an industrial tool and is not intended for recreational use.

Pilot Assistant | Visual Observer

A pilot assistant or visual observer is a crew member that aids the pilot before, during and post flight. Lucid recommends using a PA for every flight. The PA will help determine potential obstacles in flight, monitor the operations area, keep pedestrians clear of this area, and help the pilot notate proximity to objects. The PA will also be responsible for ensuring the hose doesn't snag on any obstacles.

The FAA requires UAS pilots to always be able to "see and avoid," any potential obstacles or other aircraft. In order to maintain this requirement, a PA or VO is necessary for all flights. In addition, the PA will aid the pilot to better understand depth perception of the drones true position in space.

Pre-Flight PA Operations:

The PA is responsible to assist the RPIC or LCP in completing the required pre-flight procedures. The PA will also aid the pilot in setting up a takeoff and landing area, setup the operational area and aid in pump/hose operation. The PA will also be tasked to lay out the hose to allow for maximum flexibility in flight. If the PA observes any deviation from the pre-flight checklist, it is their responsibility to notify the LCP. The PA should also notate any potential hazards, notate Minimum Obstacle Clearance Altitude and double check the operating environment (airspace) for potential last minute TFRs.

During Flight Operations:

The primary responsibility of the PA during flight, is to support the LCP by monitoring the drone and hose. The PA is responsible for constantly surveying the area for obstructions, hazards, bystanders, weather, other aircraft and wildlife.

Pilots may face excited onlookers asking repetitive questions. The PA is responsible for keeping the Pilot clear of distractions and communicate to onlookers that any questions will be answered upon the completion of the flight. Every minute counts.

The PA is also responsible for ensuring the hose does not snag on any objects during flight. The PA will be responsible for moving the hose to ensure it doesn't get stuck on bushes, trees, gutters or any other foreign objects that may inhibit the safety of the flight.



The pilot assistant should never stand directly beneath the drone. PA should maintain a safe distance from the aircraft while in flight.

Crew

Oftentimes, large scale operations may require additional crew members. Collectively, the LCP,PA and any additional crew members are referred to as the "Crew."

If the operation dictates a need for additional crew, setup standard forms of communication to ensure effective communication while in flight. Crew Members should be briefed prior to operation. Crew members should know their roles and responsibilities and hierarchy in the operation.

Pre-Flight Checklist & Operations

Following the Pre-Flight checklist is mandatory for any operation of the C1 aircraft. Traditionally pre-flight checks begin well before the operation starts. From checking an operation's location and airspace, to ensure proper preparation of the aircraft as a whole. Pre-Flight checks finish the moment prior to takeoff to ensure a truly safe operation. If the pre-flight checklist cannot be completed, it is the ultimate responsibility of the LCP or pilot in command to determine if a drone operation can be completed safely.

Weather & Environmental Factors

For any drone operation, weather conditions are vital for a safe flight. When conducting your flight planning for any given operation, pilots will check weather conditions to ensure for a safe operating environment. Weather will then be checked again prior to the operation, during pre-flight.

Lucid recommends checking the weather during:

1. Flight Planning
2. Day prior to operations
3. Prior to takeoff during operations.

If weather conditions cannot be met, it is the ultimate responsibility of the LCP to determine if a safe flight is possible and to determine if the flight should be terminated.

Wind

Lucid C1 drone should not be flown in sustained winds exceeding 15 mph. High winds can affect the flight safety and stability of the aircraft. Winds can also cause significant drift when spraying chemicals or water. This can lead to improper coverage and overspray of unintended surfaces. LCP and PA are responsible for checking the following wind speeds prior to flight:

1. General Forecast Wind Speeds
2. Wind Speed at Spray elevation (Using ryancarrolton.com pilots can determine winds at various altitudes, as they do change)

Advanced: Pilots can use an Anemometer to determine wind speeds at the operation location. In addition if pilots have access to a consumer drone, they can fly to a given altitude, change the flight mode to attitude mode, let the drone drift and the maximum drift speed will showcase current wind speeds. If flying in urban environments, be aware that buildings may cause pockets of wind that could impede the operation.

Fog

Lucid C1 drone should not be flown in the presence of FOG. Fog creates numerous visibility issues and creates an unsafe flying environment. Drone pilots should maintain a 500' distance below a cloud or 2000' lateral distance from clouds to remain compliant with FAA regulations.

In addition, if the temperature/dew point spread is within 5 degrees, pilots should not fly. When the temperature is 70 degrees, and the dew point is 65 degrees (or a 5 degree spread) moisture will build up on the bottom of the props decreasing available thrust. The drone should not be flown in these conditions as the aircraft will compensate for decreased thrust by over-rotating the props. This could cause damage to the batteries and in extreme cases cause a catastrophic loss.

Rain

The Lucid C1 drone is not fully waterproof. While pilots can fly in the rain, two conditions must be met. First is the regulatory condition that there is still 3 miles of visibility to fly. The second condition is that the rain is a light mist or very light precipitation. If rain begins while in flight, it is the responsibility of the LCP to determine if the flight should be ended.

KP Index

KP index is a measurement of the solar radiation striking the earth. This KP index is also indicative of the overall interference the GPS will face. IF KP index is above 5, pilots should not fly the C1 aircraft.

Civil Twilight

Flights occurring 30 minutes prior to sunrise or 30 minutes after sunset are allowed if the drone and pilot can meet regulatory conditions. If flying in this time frame, pilots must mount a strobe to the aircraft. This strobe light must be positioned on the top of the aircraft and be visible for 3 miles away. In order to fly in this time frame, pilots must take the 107 Recency course on the FAA website to comply with federal regulations.

Obstructions

When surveying a potential job site, scan the area for potential obstructions that could inhibit proper GPS connection. The Lucid C1 drone requires a precise GPS connection in order to function properly. Ensure the Lucid C1 is flying in an area clear of overhead obstructions and has a clear view of the sky to operate. Potential problems arise with trees, overhangs or multiple tall buildings surrounding the operations site. Pilots and PA's should also notate any magnetic objects, as these objects can interfere with the GPS system.

Takeoff & Landing Area

Lucid recommends the takeoff and landing area be determined during your flight planning process. On the day of the operation, the LCP should confirm the takeoff and landing area is a safe distance from objects and will ensure a safe operation. Typically if issues present themselves, it will occur during the takeoff and landing portion of the flight. The takeoff and landing area should be:

1. 20' clearance in all directions
2. Take place on a level surface
3. Have cones to designate the area
4. Determine if tape is needed to cordon off the area.

Flight Planning

Prior to the flight, the LCP should determine the flight path of the aircraft to perform the operation. Typically Flight Planning will occur prior to the operation. During flight planning the LCP should determine:

1. Airspace is clear, or file for airspace authorization
2. Determine Weather & KP Index
3. Determine operations area
4. Determine takeoff area
5. Determine Flight Path

6. Notate any obstacles or obstructions.

Crew Preparation

Once the LCP has determined the flight path, the LCP must communicate this plan to the Pilot Assistant and all relevant crew members. LCP should also instruct the crew as to their roles in the flight, to ensure a safe flight. The LCP should communicate all aspects of the flight and allow for crew members to ask any questions relevant to the operation. During crew preparation, all crew members should outfit themselves with all necessary PPE and take their respective positions.



FAA regulations require a pre-flight safety briefing to instruct all crew members of potential hazards and communicate a plan to keep civilians clear of the operating environment.

Drone Setup

Once your pre-flight safety briefing is complete, operations setup and drone setup may begin. The following steps should take place to ensure a safe operation:

1. Setup Takeoff and Landing Area
2. Set drone in takeoff position
3. Lift and lock arms into place
4. Remove the propeller guards and straighten out the propellers.
5. Screw GPS antennas onto the top of the aircraft.
6. Connect the hose to the connector beneath the drone frame.
7. Connect the sprayer nozzle to the drone using the quick connect
 - a. Ensure you hear a click to ensure the sprayer is attached properly
 - b. May pull gently on the sprayer nozzle to confirm a proper seal.
8. Place both batteries in the respective positions, strap down both batteries

Drone Hardware Checklist

Once drone setup is complete, ensure there is no damage to any integral part of the drone itself. Damage could have occurred during transportation, a previous flight, storage or a crew member fiddling with the drone. The LCP holds the ultimate responsibility to ensure a hardware check is completed prior to flight.

Pilots should check the following areas for potential issues prior to flight:

1. Propellers: Propellers should not be chipped, cracked or bent as this will cause an unstable flight and potential catastrophic loss. Propellers should not have excess debris or material on the propellers. If propellers become unbalanced, the props will fail in flight. As noted in our training course, propellers are the most commonly replaced parts of any drone. Follow the maintenance schedule for instructions on propeller replacement. We advise if propellers hit a tree, bush or other object, they should be replaced immediately.
2. Motors: Motors should be level and spin freely upon testing. Prior to the flight, crew should confirm the motors are level and spin freely without making noise. Motors should also be free of debris.
3. Screws: inspect the drone for loose or missing screws, any loose screws should be tightened.

4. Landing Gear: inspect the landing gear for damage or loose screws. Ensure the landing gear is not bent, dented or cracked.
5. Hose Mount: Ensure the hose is properly aligned beneath the drone. The hose should be properly attached and laid out to ensure an effective operation.

Connecting the Drone

Once the takeoff area has been setup, the drone hardware checked and safety briefing complete, the LCP is ready for final stages of prep, prior to take off. At this point, you should be ready to conduct the operation.

1. Connect battery plugs to aircraft plugs.
 - a. Connect both power and balance cables.
2. Turn on the remote controller by depressing the power button once, then press and hold.
3. Unlock the tablet by swiping up on the screen.
4. Open QGroundControl application on the controller.
5. On the top left of the screen find the “Q” icon, and press it.
6. Click application settings
7. Click on “Comm Links”
8. Select the communication channel, click disconnect
 - a. This will take approximately 10-20 seconds to complete
 - b. Click the communication channel again
 - c. Click connect
9. Click on the paper airplane icon on the top left to return to the home screen.
10. Wait for the drone to complete downloading parameters.
11. Ensure the drone has full GPS connection depicting “RTK Fixed”
 - a. If the drone takes more than 5 minutes to achieve the RTK Fixed, consider moving your takeoff location for better GPS reception.



Pilots will have to disconnect and reconnect the communication port prior to every flight. Automatic connections can cause Application display issues and lead to delayed telemetry.

In-Flight



READ THIS ENTIRE SECTION PRIOR TO FLYING THE DRONE.

FLIGHT FAILSAFES

The Lucid C1 drone offers multiple flight failsafes to remind the pilot of potential issues. The failsafes were programmed into the drone to minimize potential dangers while flying.

Radio Failsafe

Radio failsafes were built in to aid the pilot in the event of a loss of remote control connection or power loss on the remote. If the remote control becomes disconnected or the battery dies, the Lucid C1 drone will hover for 5 seconds then initiate an auto landing procedure.

Operational Geofence

The C1 drone has a pre-programmed altitude limit of 115 and a lateral limitation of 200'. The cylindrical geofence creates a 200' radius from the initial takeoff position. The purpose of this geofence is to prevent the pilot from flying beyond the range of the attached hose. Once the pilot flies beyond the geofence boundary, the drone will automatically switch the flight mode to Brake and movement will be restricted. Pilots will need to switch the flight mode to "loiter" to regain control.

It is important to note that pilots can bypass the limitations of the drone. Pilots should only bypass the limitations when the operation requires a higher altitude or longer distance to fly.

Obstructions & Obstacle Avoidance

As stated previously, the LCP is ultimately responsible for the safety of the operation. Pilots may use discretion when operating the C1 drone, and may determine when to use obstacle avoidance on the aircraft.

Obstacle Avoidance

Your Lucid C1 drone is equipped with a forward facing obstacle avoidance. This radar based system operates within a 45 degree field of view from the front of the drone. When activated on the remote, the obstacle avoidance will give you a 15' buffer from any obstacle in front of the drone.

When taking flight for operations, ensure the obstacle avoidance toggle is depressed forward to activate the obstacle avoidance. Prior to cleaning operations on a building, activate the toggle to engage the avoidance.



Obstacle avoidance is only available for forward facing objects. Maintain a safe flight distance or buffer from the drone to other obstacles, side facing, rearward facing, of at least 20 feet.



Pilots should always maintain a 9 foot physical distance from any obstacle regardless of the operation being performed.

Flight Orientation

During flight operations, the Lucid C1 drone's orientation should match the pilots orientation. This is recommended to avoid inadvertent flight controls. As lateral motions on the controller will be inverted when the drone is facing the pilot. The Lucid C1 drone was designed to easily discern drone orientation.

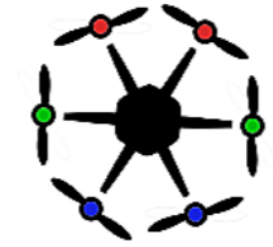

The front of the Lucid C1 drone has two red lights equipped below the motors. The rearward facing motors will illuminate blue. The pilot should always be looking at the back of the drone when flying, meaning they will see the blue lights for most of the flight. Drone orientation can also be discerned by looking for the sprayer nozzle which is fitted to the front of the aircraft. Pilots can add reflective red tape to the front arms of the drone to make orientation easier to discern. Although it is recommended to not add very much tape, as you do not want to throw off the weight and balance of the drone.

Takeoff Protocols & Rules of Takeoff

One of the most dangerous aspects of drone flight centers around takeoff and landing. Although many liabilities and risks can be mitigate by following the same workflow...every time you fly the C1. Pilots can also create habits by practicing the rules of takeoff to further mitigate liability.

Pilots and crew should stay clear of the drone upon takeoff. Lucid recommends staying 20 feet clear of the drone upon takeoff. Prior to takeoff, follow the hardware checklist and pre-flight checklist. In addition, the LCP should confirm that all participants are clear of the takeoff area and are wearing the proper safety equipment.

1. Ensure all pre-flight checks are complete
2. Ensure all hardware checks are complete
3. Once Remote has required RTK Fix, its time to takeoff!
4. While holding the left stick down, arm the drone by moving the arm toggle to the forward position.
5. Allow the propellers and motors to spin up.
6. Push the left stick, or elevation stick up to about 75%.
7. Takeoff and move up and away from the takeoff position.
8. Let the drone hover for a few seconds, make sure the drone is not "toilet bowling,"
 - a. Toilet bowling indicates a GPS error, land immediately
9. Next conduct a control sweep to ensure the remote and drone are responding normally.
10. Conduct your battery test

Rules of Takeoff

Every time you fly the C1 drone or any drone, your pilots should follow the rules of takeoff to avoid potential errors in flight. These rules of takeoff will create habits with your pilots, that will create routines. These routines will become automatic and help you systematically eliminate liability in flying the drone.

Rules of Takeoff Include:

1. Takeoff into the wind.
2. Drone and Pilot should have the same orientation
3. Takeoff, Move up 10' and move out 10'. Conduct control sweep and battery test.

Control Sweep is a quick test of the drone and remote. The pilot should simply move the roll stick to the right, moving the drone a few feet. Roll back to the left to get back to your original position. Then pitch the drone forward just for a few feet, pitch it back to the original position. The control sweep ensures that the remote and drone are communicating properly, without latency. In addition, if the drone lags during this period you could be flying in a dense wifi environment. A dense wifi environment will subject the drone to vast amounts of radio interference. If the pilot notices significant latency from inputting the controls to control execution, they should land immediately.

Battery tests are the ultimate indicator of a safe flight. It is the only true way to determine if your batteries are safe to fly. The battery test will also account for all environment factors of the flight. Battery percentage will now account for elevation, temperature, relative humidity, wind or other factors.

To conduct a battery test, as according to the 3rd rule of takeoff, Ram the elevation stick up for approximately 5 seconds. If your aggregate battery voltage drops below 44 volts... Land immediately. For other consumer drones, you're looking to see if the battery cell voltage drops below 3.6 volts PER CELL.

The battery test is the ultimate indicator of a safe flight, it is analogous to an "engine run-up test," on fixed wing aircraft.

Flying with the hose attached.

Flying the Lucid C1 drone with the hose attached will "feel" different to the pilot. There will be a noticeable difference in how the drone handles. Agility will be greatly reduced in order to maintain stability.

Pilots will notice the C1 drone will feel more sluggish due to the increased weight and payload of the system. Pilots must be constantly accounting for "hose drag" when flying the drone, especially when flying further away from the pump or anchor point. Lucid recommends the pilots should lay out the hose prior to takeoff to ensure they have the optimum amount of slack on the hose.

If the drone seems to be tilted and appears to be working hard to maintain its position, without input, it could be due to an excess amount of hose dragging on the ground. The pilot assistant should be constantly checking the hose to allow for enough slack in the hose line. This will help prevent the drone from working too hard and using too much battery power. The drone will have drastically reduced flight times if hose management is not executed during the flight.

Pilots and pilot assistants should be constantly monitoring the hose to ensure the hose does not become snagged on any potential object. If the hose does become snagged on an object, the Pilot should input commands to release tension on the hose. Typically this will involve having the pilot move the drone back to its prior position as to not have increased tension on the hose and drone.

Pilots and Pilot assistant should attempt to have the hose laid out to match the spraying/rinsing flight pattern of choice. The drone should not be dragging hose line across the ground.

Landing Protocols & Rules of Landing

To land the drone, the pilot should return to the takeoff area or another predetermined landing zone. When approaching the landing zone, allow the drone to stop and hover in a fixed location.

The pilot should command the drone to descend as slowly and consistently as possible to land the aircraft. Pilots may face increased “prop wash” when landing the drone, and should focus on small and consistent inputs on the remote to control the drone.

Landing the drone is the ONLY time pilots should fly straight down. Pilots should always descend the aircraft in some sort of pattern to avoid straight down flight.

When landing, ensure the drone is free of obstructions and other obstacles. Have the pilot assistant wrangle the hose to avoid any snags while the drone is landing. Once the pilot has landed, the drone will need to be disarmed.

Landing protocols:

1. Approach the designated landing zone, but keep the drone orientation identical to the pilots orientation.
2. Begin descending by lowering the elevation stick (left stick on the controller)
 - a. This should be done as slowly and as consistently as possible.
3. When flying with the hose attached, pilots may have to roll the aircraft back and forth to lay out the hose to inhibit a prop strike upon landing.
4. As you approach the ground (<5') ensure the hose is not bunched up beneath the drone
5. As the drone is touching down, and once it has touched down, hold the elevation stick (left stick) all the way down.
6. Upon touchdown, and while holding the elevation stick down, move the arm toggle down to disarm the motors.
7. After you have landed, unplug the batteries on the aircraft.

C1 Spraying/Rinsing Flight Patterns

Lucid recommends 4 separate flight patterns for utilizing your C1 drone. These 4 patterns are broken down into 2 separate categories.

Category 1 of these patterns is for spraying, cleaning or spraying a solvent. This category has two flight patterns. The major differentiator with spraying patterns, is that the aircraft always starts the pattern at the bottom of the building.

Category 2 of these patterns is for rinsing. This category also has two flight patterns, yawing and grid. The major differentiator with rinsing patterns is that the flight pattern will start at the TOP of the building. This way we can use the drones prop wash to accelerate the rinsing process.

Pilots may find one particular pattern more efficient than the other. The two patterns for spraying are broken down by the YAW pattern and the Grid Pattern.

Let's use the example of the Rinsing Yaw pattern to showcase this flight pattern. Starting at the top of the building, we will slowly descend. As the aircraft descends, the pilot will rotate the drone left and right to spray the wall. Once they reach the bottom of the building, they will ascend back to the top, roll slightly along the wall and continue descending while yawing.

The grid pattern is much more simple and does not require the use of Yaw or rotation. Let's use the example of rinsing one more time. Starting at the top of the building, we will roll across the building. We will then descend a few feet and roll the opposite direction across the building.

Again pilots may find one particular method more effective than the other dependent upon the type of cleaning operation you are conducting. After flying the Lucid Drone for 6 months, the Drone U flight crew has found that grid patterns allow pilots to have greater flight times. Albeit we are not cleaning specialists or chemists, so pilots use your best judgment when choosing your flight pattern.

Post Flight Process

Once drone operations have finished, drone teams will have to properly dismantle and store the C1 Drone. The post flight process is simply the inverse process of setup. Proper post flight procedures will be critical to maintaining the drone over time.

Post Flight Procedures

1. Drone has landed
2. Turn off the ground based pump
3. Allow the sprayer to continue to run to release any pressure in the hose.
4. Turn off sprayer
5. Unplug the aircraft batteries and place them in a fire-resistant container
6. Turn off the remote controller
7. Disconnect the hose from the drone.
 - a. Ensure steps 2 & 3 have been completed prior to disconnecting the hose.
 - b. Disconnecting the hose under pressure will cause rapid discharge of water or liquid material which could damage the aircraft or contaminate the pilot.
8. Disconnect the sprayer nozzle from the drone using the quick release
9. Detach the GPS antennas and place them in the remote controller case
10. Wipe the drone down
 - a. IF BLEACH was used in the operation, then spray the drone with bleach neutralizer during cleanup.
11. Attach propeller guards to the arms, fold the props and put props in propeller guards.
12. Fold all six arms of the drone.
 - a. Pilots will find 2 red buttons at the mount of the arm.
 - b. Depress both red buttons to release arms and lower them.
13. Place drone in the carrying case
14. Place remote in the carrying case
15. Place sprayer in carrying case or other case.

Cleaning the Drone & Site.

After each operation with the Lucid C1 drone, it is recommended that pilots take time to clean up the aircraft. There are various methods of cleaning the drone, they differentiate based on what chemicals or liquid was used during the operation.

If spraying just water from the drone:

1. Wipe the drone down with a microfiber cloth,
2. Ensure no water is pooling or collecting in various areas of the drone.
3. Use cleaning putty on the drone to clean difficult-to-reach areas of the aircraft.

If spraying with bleach:

1. Wipe the drone down with a microfiber cloth
2. Use bleach neutralizer to remove any excess material from the drone.
3. Wipe again to remove any excess neutralizer
4. Still recommend using cleaning putty on the drone to clean difficult-to-reach areas

If spraying with chemicals:

1. Wipe the drone down with a microfiber cloth
2. Use any necessary chemical or neutralizing agent to remove hazardous chemicals.
3. Wipe down again using clean cloth.

Professionalism is key when operating complex machinery or aircraft. As such, pilots and crew should always plan for time to clean up the operations area after an operation. After a drone operation has been completed, ensure to pick up:

1. Pack all drone equipment,
2. Pack batteries in a fire resistant container, store the batteries in a climate controlled environment.
3. Pack any auxiliary equipment
4. Pack any cones, pick up tape and ensure you leave the area as you found it.



Do not pack batteries or store batteries in your work vehicle. Do not leave batteries in direct sunlight or extreme temperatures. It is highly recommended that you have systems in place to properly store the aircraft and batteries.

Mission Planning & Scouting Job Sites

Cleaning companies often bid on jobs using various equipment and tools to perform their job. The Lucid C1 drone offers a strategic advantage to cleaning companies to offer a more efficient and safe means of completing certain jobs. It is important to note that there are limitations when using drones to clean. Oftentimes airspace could provide complexities and increased administrative time to complete jobs.

Lucid recommends that the pilot or Lucid Certified Pilot should participate in the bidding process, whenever operations are considering drone utilization. Even if a job is awarded to the cleaning company, the LCP is ultimately responsible for safe use of the drone. There may be jobs that dictate a higher risk profile and may be too dangerous to use the drone. The LCP must ensure the drone's use will still be executed with safety in mind.

When bidding cleaning jobs, that require the use of the Lucid Cleaning drone, the estimator or bidder should consider the following:

1. Location of the cleaning operation.
 - a. Is the location in controlled Airspace
 - b. Does the airspace offer LAANC access or autonomous airspace approval?
 - c. If the airspace is in a zero grid, will you have ample time to file for a Wide Area Authorization?
2. Building Type and Operational Environment
 - a. Even if airspace is clear and flyable, is the location sufficiently clear of obstacles to operate the aircraft?
3. Logistics of Drone Operations
 - a. Will you have sufficient access to water?
 - b. Will you be able to access the operational area with ease
 - c. Will you be able to have your pump or vehicle close enough to the operation to use the Lucid C1 drone?
4. Weather conditions
 - a. Consider time of year, temperatures and potential wind.

Takeoff & Landing Areas:

It is important to note the Lucid C1 drone requires a flat and level surface sufficient for takeoff. While not all job sites will provide a perfectly level takeoff area, it is up to the LCP to determine the best area for takeoff and landings. Taking off from an uneven surface, or landing from an uneven surface can cause the drone to become unstable, difficult to control and could lead to a crash. During the bidding process, consider the operations area for the Lucid C1 drone. Identify potential areas for takeoff and landing. If there is no appropriate location for the takeoff and landing zone, the drone may not be suitable for the job.

Pilots should also consider any potential obstructions or obstacles. Consider trees, flagpoles, access areas, traffic areas, pedestrian traffic and distance from tall buildings. Consider any logistic issues that may present themselves when operating the Lucid C1 drone. Should parking spaces be cordoned off to create a safe area? If so plan for this and communicate with the building manager to plan appropriately for any actions that need to take place to create a safe operating environment.

Airspace and FAA Regulations.

Remember the Pilot or LCP is ultimately responsible to comply with all Federal regulations set forth by the FAA. Pilots should always consider airspace when planning for a drone operation. Pilots can access airspace maps in a variety of methods.

Desktop:

The FAA provides an online registry of all LAANC activated airports. The [FAA's UASFM \(Unmanned Aerial Systems Facility Maps\)](#) Map will display a comprehensive map of all airspace across the country. These maps will showcase airspace specific to UAS or drones. The maps will also showcase the maximum allowed altitude in a given area. Pilots can fly in these grids, and gain autonomous airspace authorization if they fly below the given altitude limit. If pilots need to fly higher than the prescribed limit, they will have to apply for an airspace authorization through the FAA's online portal (discussed on the next page)

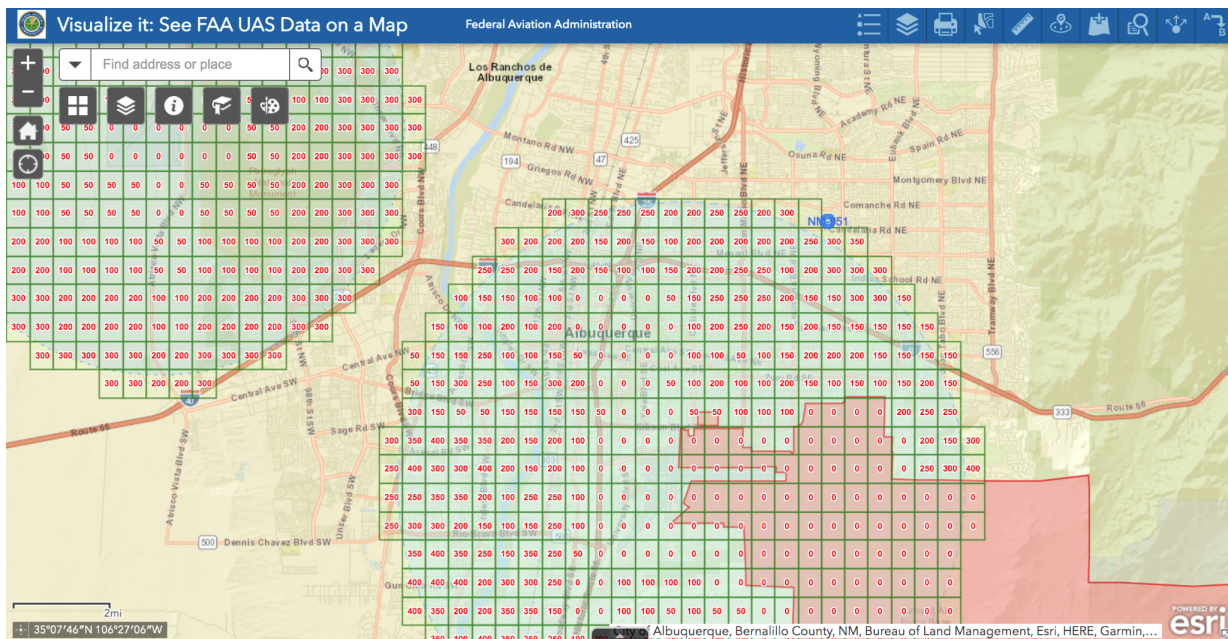

Mobile Apps:

View airspace on mobile applications to make discerning operational applicability.

[Open Sky by Google](#)

[UA Sidekick](#)

To operate in controlled airspace, pilots may have to apply for a LAANC airspace authorization. This can be done using a variety of methods from phone applications. Pilots can apply through the open sky application or through the UA sidekick application.

If pilots cannot gain an autonomous airspace authorization through LAANC, they will have to file for an airspace authorization through the FAA portal. Reasons to file for WAAS authorization:

1. Need to fly higher than altitude limit
2. Need to fly in a “zero grid,”
3. Airport is not LAANC activated.

FAA Airspace Authorization (Non-Laanc)

In order to gain airspace authorization for a given area, pilots will need to apply through the FAA’s online portal. Pilots can visit: <https://faadronezone.faa.gov/>

After pilots create a login, which you should already have at this point, you can apply for airspace authorizations. Once you login, you will be taken to your dashboard. Scroll down to see 107 Airspace authorizations and click “Create 107 Waiver/Authorization.”

The screenshot shows the FAA DroneZone website dashboard. The main heading is "Part 107 Waivers & Airspace Authorizations". Below this, there is a brief introduction and a list of resources for operational waivers and airspace authorizations. On the right side, there is a summary section titled "Total Part 107 Waivers & Authorizations" with a donut chart showing 6 total authorizations: 1 Approved (dark blue), 4 Canceled (FAA) (gold), and 1 Draft (light blue). A button labeled "Create Part 107 Waiver/Authorization" is visible at the bottom right.

Category	Count
Total Part 107 Waivers & Authorizations	6
Approved	1
Canceled (FAA)	4
Draft	1

1. Users will have to click “ airspace authorization,”
2. Click Start Application to start the application process of acquiring an authorization.

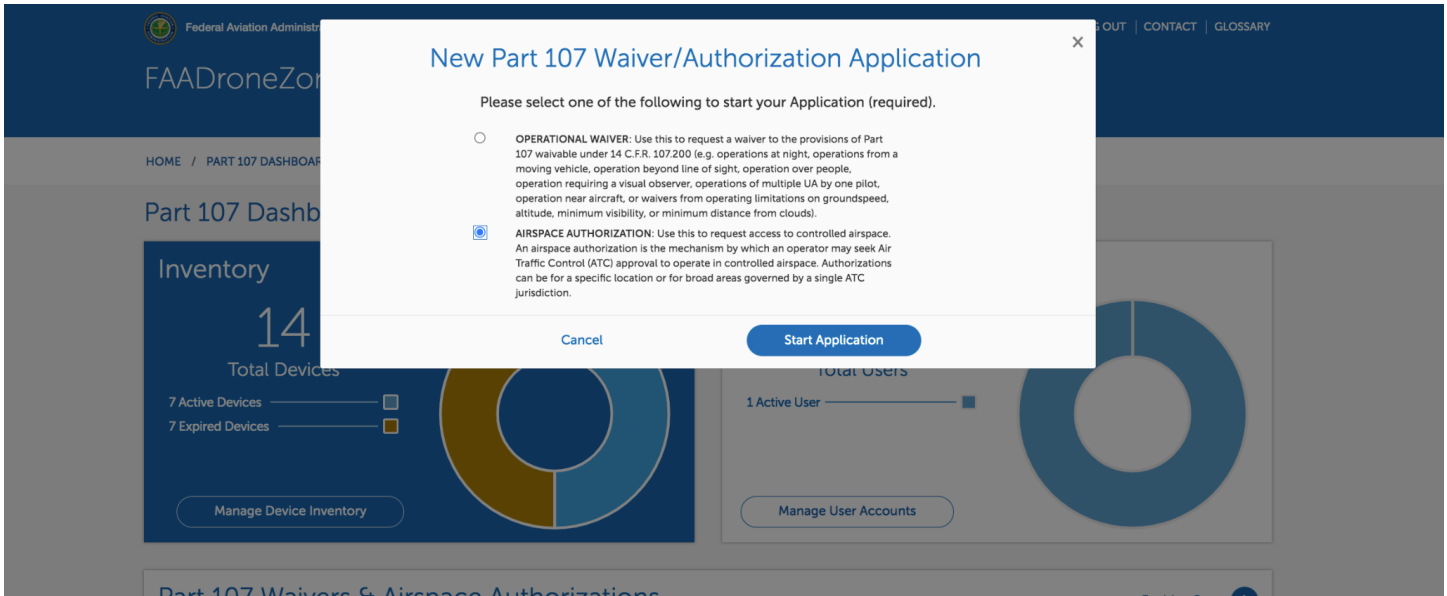

3. Enter the operational title, create a system to name your cleaning jobs to keep track of airspace authorizations. Think of naming the operations based on the client name or address.

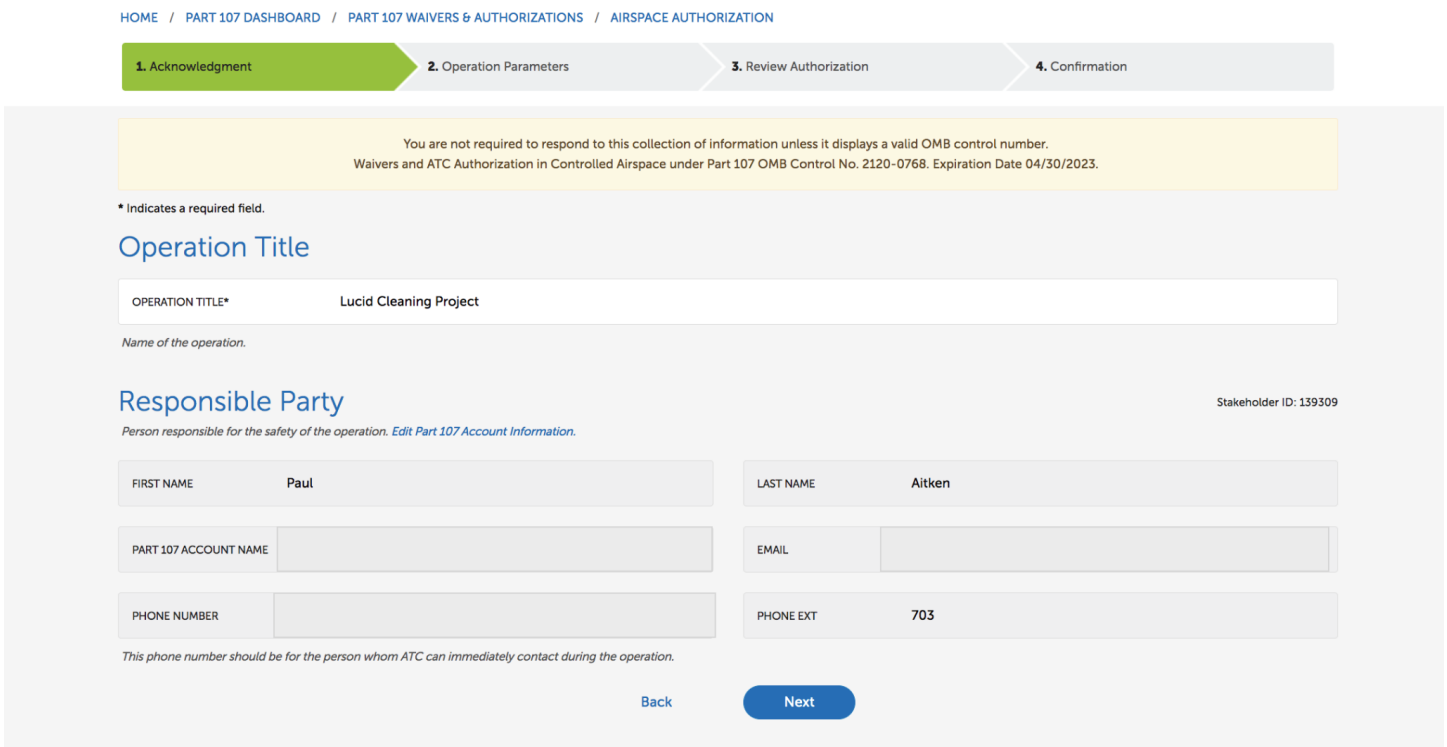

4. For the next step, you will enter the operational parameters of the application itself. There are a few hacks here to make this process much easier.
 - a. For example, if you're applying for an airspace waiver in controlled airspace that has a LAANC active, you will need to apply for one specific date. The system will not allow you to set a date range if LAANC is active at the airport.
 - i. If you're planning on flying multiple days, you will simply input the date range or proposed days of operations in the comments section.
 - b. Another workflow hack to make this process easier. Pull up the location for the proposed operation in google maps. Double click on an area nearby, the pin will showcase GPS coordinates. Click the coordinates, as the coordinates will display in your browser tab... and make it easier to enter the coordinates into the FAA website. (See training video)
 - c. Give yourself flexibility due to weather. The FAA understands you want to operate safely, and asking for a window of flight time due to potential weather issues is totally acceptable. Contingencies allow for everyone to operate safely. Do not confine yourself to a specific flight time.
 - d. When applying for altitude, make sure to note in the comments the nearest MOCA altitude to the operation. (Minimum obstacle clearance altitude) If the FAA knows there is a building or radio tower at a much higher altitude than your proposed operation, they are more likely to approve the request.

HOME / PART 107 DASHBOARD / PART 107 WAIVERS & AUTHORIZATIONS / AIRSPACE AUTHORIZATION

1. Acknowledgment → 2. Operation Parameters → 3. Review Authorization → 4. Confirmation

* Indicates a required field or that a selection is required.

Operation Parameters

START DATE*

END DATE*

Dates cannot be in the past or exceed 24 months from today's date.

TIMEFRAME* SUNRISE TO NOON NOON TO 4 PM 4 PM TO SUNSET NIGHT

FREQUENCY*

LOCAL TIME ZONE*

PROPOSED LOCATION OF OPERATION* Provide the specific area within the class of airspace that you wish to operate.

0/15000 characters.

PROPOSED MAXIMUM FLIGHT ALTITUDE ABOVE GROUND LEVEL (AGL)* ft.

Note: Operations over 400 ft AGL may require a waiver to 14 C.F.R. § 107.51(b)

Latitude

DEGREES* MINUTES* SECONDS* DIRECTION*

Longitude

DEGREES* MINUTES* SECONDS* DIRECTION*

RADIUS*

NEAREST AIRPORT*

CLASS OF AIRSPACE*

Three or four character Airport Identifier

DESCRIPTION OF YOUR PROPOSED OPERATION* Purpose of operation and method by which the proposed operation can be safely conducted.

5. Review the application and then submit the application. The FAA states to give them 90 days to review, but during the filming of this course, we acquired same day authorization. Provide as much time as possible for the review of authorizations.
6. Once you have submitted the application, you can find a list of your airspace authorizations on your dashboard.
 - a. KEEP A CLOSE EYE on email. As the FAA may email you with clarifying questions. The faster you respond, the faster they work for you.
 - b. You should receive an answer within 72 hours if not sooner.

FAADroneZone PART 107

HOME / PART 107 DASHBOARD / PART 107 WAIVERS & AUTHORIZATIONS

Part 107 Waivers & Authorizations [Create Part 107 Waiver/Authorization](#)

SEARCH Search for waivers and authorizations

SHOWING ITEMS 1 - 6 OF 6 TOTAL ITEMS. FILTER BY All Part 107 Waivers / Authorizations

TITLE	DATE	APPLICANT	TYPE	STATUS	REFERENCE NUMBER
Cinewhoop Production	03/28/2022	Paul Aitken	Airspace Authorization	Approved	2022-P107-CSA-07395
Cinewhoop Production	03/28/2022	Paul Aitken	Airspace Authorization	Canceled (FAA)	2022-P107-CSA-07397
Cinewhoop Production	03/28/2022	Paul Aitken	Airspace Authorization	Canceled (FAA)	2022-P107-CSA-07402
Cinewhoop Productio...	03/28/2022	Paul Aitken	Airspace Authorization	Canceled (FAA)	2022-P107-CSA-07396
Lucid Cleaning Operati...		Paul Aitken	Airspace Authorization	Draft	2022-P107-CSA-07427
OBRT5-1	10/10/2020	Paul Aitken	Airspace Authorization	Canceled (FAA)	2020-P107-WSA-22188

Limitations:

When planning operations remember the limitations of flight operations as a whole.

1. Plan for obstructions
 - a. Trees
 - b. Powerlines
 - c. Interference
2. Check airspace always
3. Ensure the drone is registered.
4. Ensure you can restrict pedestrians from the operating area
5. Plan for vehicle traffic. You cannot operating over people, or over moving cars.

Maintenance Schedule

Just like your vehicles, drones require regular maintenance. Drones typically require MUCH LESS maintenance than a vehicle. Attention to detail could mean the difference between a successful operation and a catastrophic crash.

We have developed the following maintenance schedule as a guide to help pilots maintain their aircraft and keep them in peak operating condition.

We have broken down the maintenance schedule by how many hours have been flown on the drone.

10 Flight Hours

1. Deep Cycle Charged the Batteries
2. Check GPS Antennas
3. Check for frame cracks
4. Check props tightness
5. Check for loose arms
6. Check Hose Connection
7. Spin motors and props to ensure they are clear of debris.
8. Tighten Landing Gear Screws
9. Tighten folding arm mount screws.
10. Clean the drone (consider using putty)
 - a. Arms
 - b. Frame
 - c. connectors



50 Flight Hours

1. Deep Batteries
2. Frame Checkup
 - a. Check upper and lower plates for cracks and damage
 - b. If Cracks exist, call lucid for further support
3. Check frame Arm locks for wear
4. Check frame arms to ensure still tight and not loose
5. Turn on aircraft and check for abnormal noise
6. Check Payload plate, or isolate plate, tighten screws if necessary
7. Check cables, don't move them aggressively
8. Tighten any screws that seem loose
9. Apply threadlocker to any screws that may need it.
10. Check motor bases for cracks or damage
11. Ensure arms lock in place at correct altitude
12. Check Landing Gear Screws, tighten if necessary
13. Spin Motors and Propellers to ensure they spin freely
14. Check remote controller, check for damage
15. Check remote controller antennas for damage
16. Spray motors with keyboard duster to ensure the motors are free of debris.

100 Flight Hours

1. Deep Batteries
2. Frame Checkup
 - a. Check upper and lower plates for cracks and damage
 - b. If Cracks exist, call lucid for further support
3. Check frame Arm locks for wear
4. Check frame arms to ensure still tight and not loose
5. Turn on aircraft and check for abnormal noise
6. Check Payload plate, or isolate plate, tighten screws if necessary
7. Check cables, don't move them aggressively
8. Tighten any screws that seem loose
9. Apply threadlocker to any screws that may need it.
10. Check motor bases for cracks or damage
11. Ensure arms lock in place at correct altitude
12. Check Landing Gear Screws, tighten if necessary
13. Spin Motors and Propellers to ensure they spin freely
14. Check remote controller, check for damage
15. Check remote controller antennas for damage
16. Spray motors with keyboard duster to ensure the motors are free of debris.
17. TAKE PROPS OFF OF THE MOTORS
18. TURN ON THE DRONE, START MOTORS TO CHECK MOTOR SPIN AND FREE OF DEBRIS.
19. Listen to the motors for abnormal sounds.
20. REPLACE THE PROPELLERS, DO NOT INSTALL OLD PROPS.
21. Check battery cables for abrasions.
22. Update the drone firmware if necessary.

2 Years of Lucid Drone Flights

After owning the drone for a period of 2 years, you should plan to conduct the following precautions.

1. Conduct a 100 hour maintenance inspection.
2. Replace propellers
3. Replace all batteries
 - a. Batteries should last 150 cycles, at Drone U we recommend replacing batteries at about 2 years no matter what.
4. Renew Part 107 Certificate.



Thank You

**For completing this operations manual.
Enjoy taking flight with your Lucid C1 Drone.**

